

**PKU 4000B PI series** Intermediate Bus Converters  
 Input 36-75 V, Output up to 20 A / 100 W

EN/LZT 146 376 R3B July 2009

© Ericsson AB

**Key Features**

- Industry standard Sixteenth-brick  
 33.0 x 22.9 x 8.3 mm (1.3 x 0.9 x 0.327 in.)
- High efficiency, typ. 93.4 % at 5 Vout 50 % load
- 1500 Vdc input to output isolation
- Meets safety requirements according to IEC/EN/UL 60950
- More than 1.6 million hours MTBF

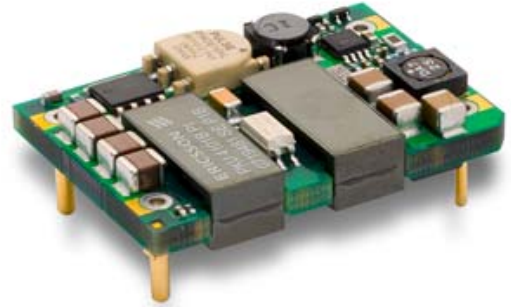

**General Characteristics**

- 1+1 parallelable
- Input under voltage protection
- Over temperature protection
- Output over voltage protection
- Output short circuit protection
- Remote control
- Highly automated manufacturing ensures quality
- ISO 9001/14001 certified supplier

**Safety Approvals**



**Design for Environment**



Meets requirements in high-temperature lead-free soldering processes.

**Contents**

|                                     |                      |
|-------------------------------------|----------------------|
| Ordering Information                | 2                    |
| General Information                 | 2                    |
| Safety Specification                | 3                    |
| Absolute Maximum Ratings            | 4                    |
| Electrical Specification            |                      |
| 5.0V, 20 A / 100 W                  | PKU 4101B PI ..... 5 |
| 12.0V, 8.3 A / 100 W                | PKU 4104B PI ..... 8 |
| EMC Specification                   | 11                   |
| Operating Information               | 12                   |
| Thermal Consideration               | 13                   |
| Connections                         | 13                   |
| Mechanical Information              | 14                   |
| Soldering Information               | 16                   |
| Delivery Information                | 17                   |
| Product Qualification Specification | 18                   |

**PKU 4000B PI series Intermediate Bus Converters**  
Input 36-75 V, Output up to 20 A / 100 W

EN/LZT 146 376 R3B July 2009

© Ericsson AB

**Ordering Information**

| Product program | Output                |
|-----------------|-----------------------|
| PKU 4101B PI    | 5.0 V, 20 A / 100 W   |
| PKU 4104B PI    | 12.0 V, 8.3 A / 100 W |

Product number and Packaging

| PKU XXXXX n <sub>1</sub> n <sub>2</sub> n <sub>3</sub> n <sub>4</sub> |                |                |                |                |
|---|----------------|----------------|----------------|----------------|
| Options   | n <sub>1</sub> | n <sub>2</sub> | n <sub>3</sub> | n <sub>4</sub> |
| Mounting  | X              |                |                |                |
| Remote Control logic  |                | X              |                |                |
| Lead length   |                |                | X              |                |
| Delivery package information  |                |                |                | X              |

| Options        | Description                           |
|----------------|---------------------------------------|
| n <sub>1</sub> | PI Through hole<br>SI Surface mount   |
| n <sub>2</sub> | Negative *<br>P Positive              |
| n <sub>3</sub> | 5.30 mm *<br>LA 3.69 mm<br>LB 4.57 mm |
| n <sub>4</sub> | /B Tray<br>/C Tape and Reel           |

Example a through-hole mounted, positive logic, short pin product with tray packaging would be PKU 4101B PIPLA/B.

\* Standard variant (i.e. no option selected).

**General Information**

**Reliability**

The Mean Time Between Failure (MTBF) is calculated at full output power and an operating ambient temperature (T<sub>A</sub>) of +40°C, which is a typical condition in Information and Communication Technology (ICT) equipment. Different methods could be used to calculate the predicted MTBF and failure rate which may give different results. Ericsson Power Modules currently uses two different methods, Ericsson failure rate data system DependTool and Telcordia SR332.

Predicted MTBF for the series is:

- 1.6 million hours according to Telcordia SR332, issue 1, Black box technique.

The Ericsson failure rate data system is based on field tracking data. The data corresponds to actual failure rates of components used in ICT equipment in temperature controlled environments (T<sub>A</sub> = -5...+65°C). Telcordia SR332 is a commonly used standard method intended for reliability calculations in ICT equipment. The parts count procedure used in this method was originally modelled on the methods from MIL-HDBK-217F, Reliability Predictions of Electronic Equipment. It assumes that no

reliability data is available on the actual units and devices for which the predictions are to be made, i.e. all predictions are based on generic reliability parameters.

**Compatibility with RoHS requirements**

The products are compatible with the relevant clauses and requirements of the RoHS directive 2002/95/EC and have a maximum concentration value of 0.1% by weight in homogeneous materials for lead, mercury, hexavalent chromium, PBB and PBDE and of 0.01% by weight in homogeneous materials for cadmium.

Exemptions in the RoHS directive utilized in Ericsson Power Modules products include:

- Lead in high melting temperature type solder (used to solder the die in semiconductor packages)
- Lead in glass of electronics components and in electronic ceramic parts (e.g. fill material in chip resistors)
- Lead as an alloying element in copper alloy containing up to 4% lead by weight (used in connection pins made of Brass)

**Quality Statement**

The products are designed and manufactured in an industrial environment where quality systems and methods like ISO 9000, 6σ (sigma), and SPC are intensively in use to boost the continuous improvements strategy. Infant mortality or early failures in the products are screened out and they are subjected to an ATE-based final test. Conservative design rules, design reviews and product qualifications, plus the high competence of an engaged work force, contribute to the high quality of our products.

**Warranty**

Warranty period and conditions are defined in Ericsson Power Modules General Terms and Conditions of Sale.

**Limitation of Liability**

Ericsson Power Modules does not make any other warranties, expressed or implied including any warranty of merchantability or fitness for a particular purpose (including, but not limited to, use in life support applications, where malfunctions of product can cause injury to a person's health or life).

**© Ericsson AB 2009**

The information and specifications in this technical specification is believed to be correct at the time of publication. However, no liability is accepted for inaccuracies, printing errors or for any consequences thereof. Ericsson AB reserves the right to change the contents of this technical specification at any time without prior notice.

**PKU 4000B PI series Intermediate Bus Converters**  
Input 36-75 V, Output up to 20 A / 100 W

EN/LZT 146 376 R3B July 2009

© Ericsson AB

**Safety Specification****General information**

Ericsson Power Modules DC/DC converters and DC/DC regulators are designed in accordance with safety standards IEC/EN/UL60950, *Safety of Information Technology Equipment*.

IEC/EN/UL60950 contains requirements to prevent injury or damage due to the following hazards:

- Electrical shock
- Energy hazards
- Fire
- Mechanical and heat hazards
- Radiation hazards
- Chemical hazards

On-board DC-DC converters and DC/DC regulators are defined as component power supplies. As components they cannot fully comply with the provisions of any Safety requirements without "Conditions of Acceptability". Clearance between conductors and between conductive parts of the component power supply and conductors on the board in the final product must meet the applicable Safety requirements. Certain conditions of acceptability apply for component power supplies with limited stand-off (see Mechanical Information for further information). It is the responsibility of the installer to ensure that the final product housing these components complies with the requirements of all applicable Safety standards and Directives for the final product.

Component power supplies for general use should comply with the requirements in IEC60950, EN60950 and UL60950 "Safety of information technology equipment". There are other more product related standards, e.g. IEEE802.3af "Ethernet LAN/MAN Data terminal equipment power", and ETS300132-2 "Power supply interface at the input to telecommunications equipment; part 2: DC", but all of these standards are based on IEC/EN/UL60950 with regards to safety.

Ericsson Power Modules DC/DC converters and DC/DC regulators are UL60950 recognized and certified in accordance with EN60950.

The flammability rating for all construction parts of the products meets requirements for V-0 class material according to IEC 60695-11-10.

The products should be installed in the end-use equipment, in accordance with the requirements of the ultimate application. Normally the output of the DC/DC converter is considered as SELV (Safety Extra Low Voltage) and the input source must be isolated by minimum Double or Reinforced Insulation from the primary circuit (AC mains) in accordance with IEC/EN/UL60950.

**Isolated DC/DC converters**

It is recommended that a slow blow fuse with a rating twice the maximum input current per selected product be used at the input of each DC/DC converter. If an input filter is used in the circuit the fuse should be placed in front of the input filter.

In the rare event of a component problem in the input filter or in the DC/DC converter that imposes a short circuit on the input source, this fuse will provide the following functions:

- Isolate the faulty DC/DC converter from the input power source so as not to affect the operation of other parts of the system.
- Protect the distribution wiring from excessive current and power loss thus preventing hazardous overheating.

The galvanic isolation is verified in an electric strength test. The test voltage ( $V_{iso}$ ) between input and output is 1500 Vdc or 2250 Vdc for 60 seconds (refer to product specification).

Leakage current is less than 1  $\mu$ A at nominal input voltage.

**24 V DC systems**

The input voltage to the DC/DC converter is SELV (Safety Extra Low Voltage) and the output remains SELV under normal and abnormal operating conditions.

**48 and 60 V DC systems**

If the input voltage to the DC/DC converter is 75 Vdc or less, then the output remains SELV (Safety Extra Low Voltage) under normal and abnormal operating conditions.

Single fault testing in the input power supply circuit should be performed with the DC/DC converter connected to demonstrate that the input voltage does not exceed 75 Vdc.

If the input power source circuit is a DC power system, the source may be treated as a TNV2 circuit and testing has demonstrated compliance with SELV limits and isolation requirements equivalent to Basic Insulation in accordance with IEC/EN/UL60950.

**Non-isolated DC/DC regulators**

The input voltage to the DC/DC regulator is SELV (Safety Extra Low Voltage) and the output remains SELV under normal and abnormal operating conditions.

**PKU 4000B PI series** Intermediate Bus Converters  
 Input 36-75 V, Output up to 20 A / 100 W

EN/LZT 146 376 R3B July 2009

© Ericsson AB

**Absolute Maximum Ratings**

| Characteristics |  | min  | typ | max  | Unit |
|-----------------|--|------|-----|------|------|
| $T_{ref}$       | Operating Temperature (see Thermal Consideration section)      | -40  |     | +125 | °C   |
| $T_s$           | Storage temperature  | -55  |     | +125 | °C   |
| $V_I$           | Input voltage  | -0.5 |     | +80  | V    |
| $V_{iso}$       | Isolation voltage (input to output test voltage)               |      |     | 1500 | Vdc  |
| $V_{tr}$        | Input voltage transient ( $t_p$ 100 ms)                        |      |     | 100  | V    |
| $V_{RC}$        | Remote Control pin voltage (see Operating Information section) | -0.5 |     | 10   | V    |

Stress in excess of Absolute Maximum Ratings may cause permanent damage. Absolute Maximum Ratings, sometimes referred to as no destruction limits, are normally tested with one parameter at a time exceeding the limits of Output data or Electrical Characteristics. If exposed to stress above these limits, function and performance may degrade in an unspecified manner.

**Fundamental Circuit Diagram**

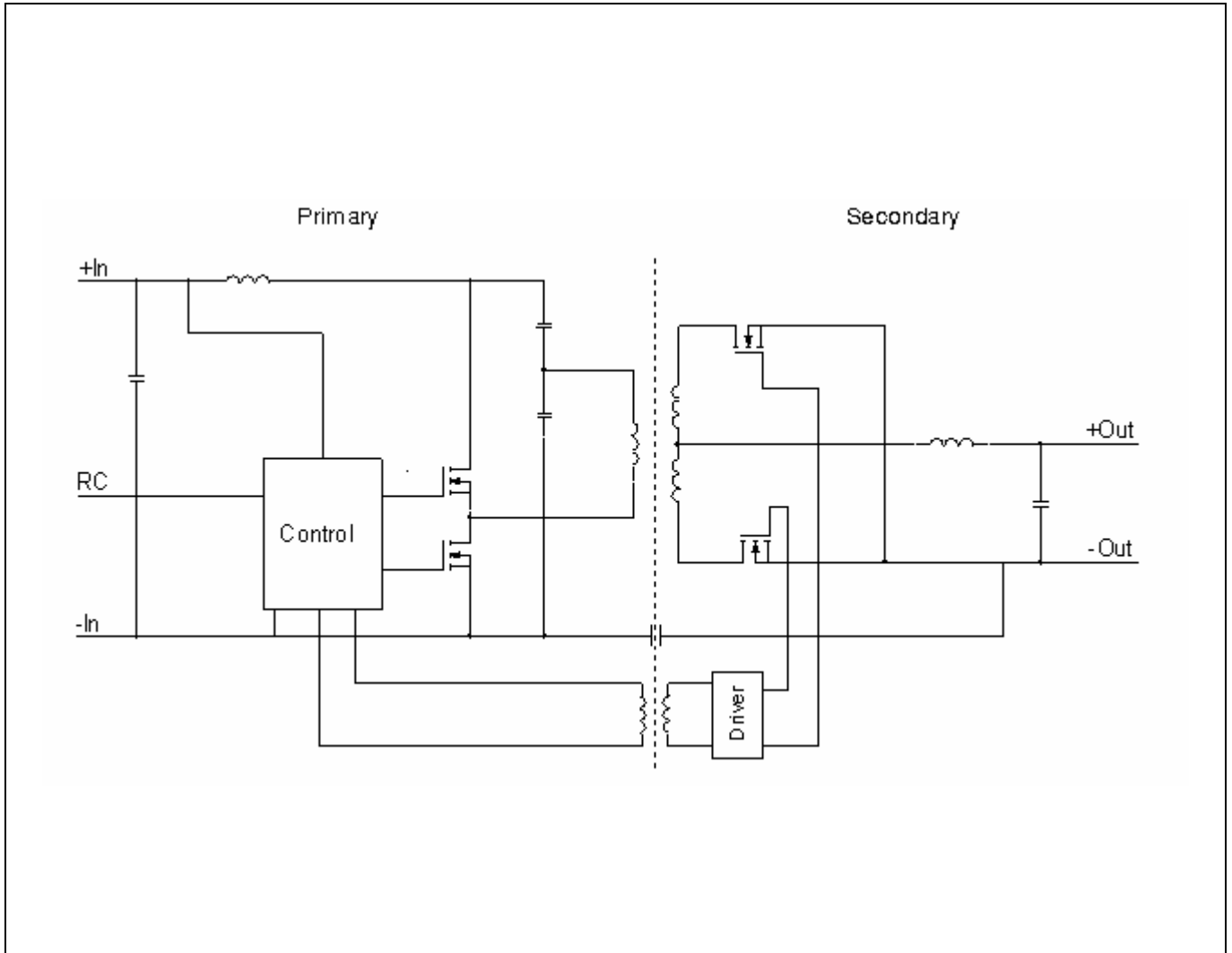

**PKU 4000B PI series Intermediate Bus Converters**  
 Input 36-75 V, Output up to 20 A / 100 W

EN/LZT 146 376 R3B July 2009

© Ericsson AB

**5 V, 20 A / 100 W Electrical Specification**
**PKU 4101B PI**
 $T_{ref} = -40$  to  $+90^{\circ}\text{C}$ ,  $V_I = 36$  to  $75$  V, unless otherwise specified under Conditions.

 Typical values given at:  $T_{ref} = +25^{\circ}\text{C}$ ,  $V_I = 53$  V, max  $I_O$ , unless otherwise specified under Conditions.

 $C_{out} = 2000$   $\mu\text{F}$ , for details see note 1.

| Characteristics |                            | Conditions                        | min | typ  | Max | Unit          |
|-----------------|----------------------------|-----------------------------------|-----|------|-----|---------------|
| $V_I$           | Input voltage range        |                                   | 36  |      | 75  | V             |
| $V_{loff}$      | Turn-off input voltage     |                                   | 29  | 30   | 32  | V             |
| $V_{lon}$       | Turn-on input voltage      |                                   | 30  | 32   | 35  | V             |
| $C_I$           | Internal input capacitance |                                   |     | 3.3  |     | $\mu\text{F}$ |
| $P_O$           | Output power               |                                   | 0   |      | 100 | W             |
| $\eta$          | Efficiency                 | 50 % of max $I_O$                 |     | 93.1 |     | %             |
|                 |                            | max $I_O$                         |     | 91.9 |     |               |
|                 |                            | 50 % of max $I_O$ , $V_I = 48$ V  |     | 93.4 |     |               |
|                 |                            | max $I_O$ , $V_I = 48$ V          |     | 91.8 |     |               |
| $P_d$           | Power Dissipation          | max $I_O$                         |     | 8.5  | 11  | W             |
| $P_{li}$        | Input idling power         | $I_O = 0$ A, $V_I = 53$ V         |     | 1.8  |     | W             |
| $P_{RC}$        | Input standby power        | $V_I = 53$ V (turned off with RC) |     | 0.11 |     | W             |
| $f_s$           | Switching frequency        | 0-100 % of max $I_O$              |     | 250  |     | kHz           |

|           |  |  |  |      |          |               |
|-----------|--|--|--|------|----------|---------------|
| $V_{oi}$  | Output voltage initial setting and accuracy                  | $T_{ref} = +25^{\circ}\text{C}$ , $V_I = 53$ V, 50 % of max $I_O$    | 4.8  | 5.0  | 5.2      | V             |
|           | Output voltage tolerance band                                | 0-100 % of max $I_O$   | 4.5  |      | 5.5      | V             |
|           | Idling voltage   | $I_O = 0$ A  | 5.0  |      | 5.5      | V             |
|           | Line regulation  | max $I_O$  |  | 0.06 | 0.25     | V             |
|           | Load regulation  | $V_I = 53$ V, 0-100 % of max $I_O$                                   |  | 0.4  | 0.6      | V             |
|           | $V_{tr}$   | Load transient voltage deviation                                     | $V_I = 53$ V, Load step 25-75-25 % of max $I_O$ , $di/dt = 5$ A/ $\mu\text{s}$ . |      | $\pm 40$ |               |
| $t_{tr}$  | Load transient recovery time                                 |  |  | 80   |          | $\mu\text{s}$ |
| $t_r$     | Ramp-up time (from 10-90 % of $V_{oi}$ )                     |  | 5  | 6    | 10       | ms            |
| $t_s$     | Start-up time (from $V_I$ connection to 90 % of $V_{oi}$ )   |  | 15   | 18   | 21       | ms            |
| $t_f$     | $V_I$ shut-down fall time (from $V_I$ off to 10 % of $V_O$ ) | max $I_O$  |  | 1.5  |          | ms            |
|           |  | $I_O = 0$ % of max $I_O$   |  | 22   |          | s             |
| $t_{RC}$  | RC start-up time   | max $I_O$  |  | 16   |          | ms            |
|           | RC shut-down fall time (from RC off to 10 % of $V_O$ )       | max $I_O$  |  | 1.5  |          | ms            |
|           |  | $I_O = 0$ % of max $I_O$   |  |      | 22       |               |
| $I_O$     | Output current   |  | 0  |      | 20       | A             |
| $I_{lim}$ | Current limit threshold                                      | $T_{ref} < \max T_{ref}$   |  | 25   |          | A             |
| $I_{sc}$  | Short circuit current  | $T_{ref} = 25^{\circ}\text{C}$ , $V_O = 0.5$ V                       |  | 32   |          | A             |
| $V_{Oac}$ | Output ripple & noise  | See ripple & noise section, max $I_O$ , $V_{oi}$                     |  | 20   | 50       | mVp-p         |
| OVP       | Over voltage protection                                      | $T_{ref} = +25^{\circ}\text{C}$ , $V_I = 53$ V, 0-100 % of max $I_O$ |  | 6.2  |          | V             |

 Note 1: Low ESR type (ESR approx 11 m $\Omega$ ). Minimum recommended capacitance for monotonic start up at 0 % load is 1000  $\mu\text{F}$  / 20 m $\Omega$ .

**PKU 4000B PI series Intermediate Bus Converters**  
 Input 36-75 V, Output up to 20 A / 100 W

EN/LZT 146 376 R3B July 2009

© Ericsson AB

**5 V, 20 A / 100 W Typical Characteristics**

**PKU 4101B PI**

**Efficiency**

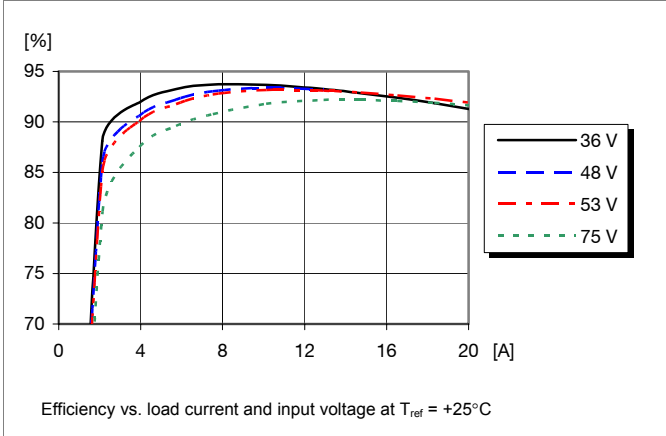

**Power Dissipation**

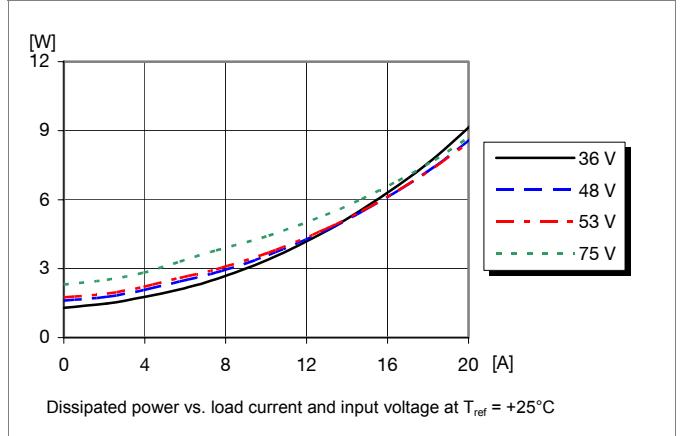

**Output Current Derating**

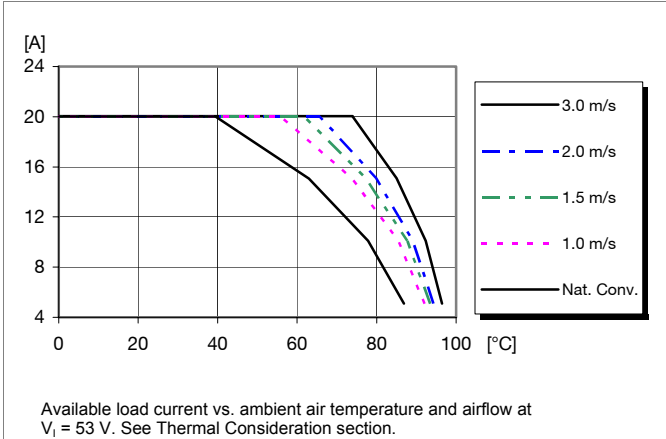

**Output Characteristics**

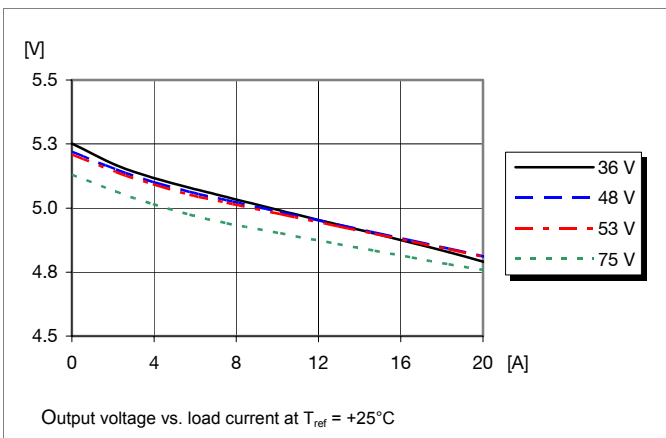

**Current Limit Characteristics**

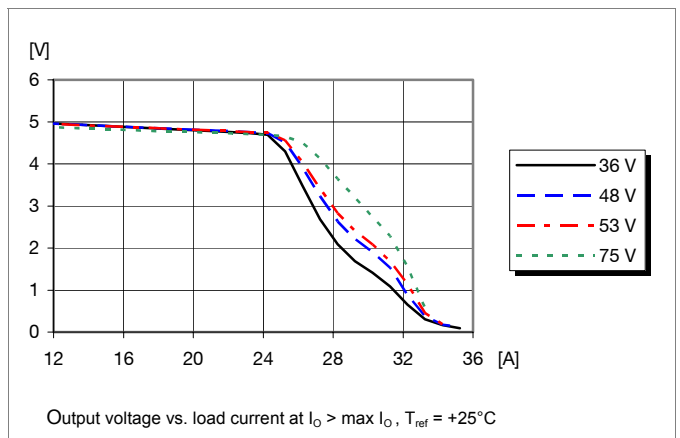

**PKU 4000B PI series** Intermediate Bus Converters  
 Input 36-75 V, Output up to 20 A / 100 W

EN/LZT 146 376 R3B July 2009

© Ericsson AB

**5 V, 20 A / 100 W Typical Characteristics**

**PKU 4101B PI**

**Start-up**

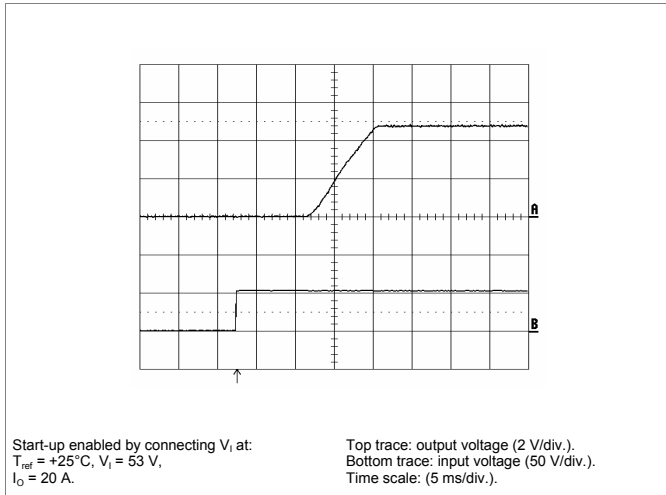

**Shut-down**

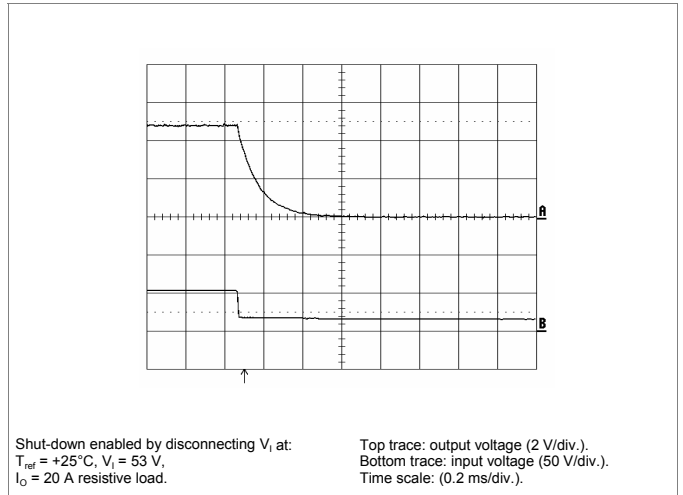

**Output Ripple & Noise**

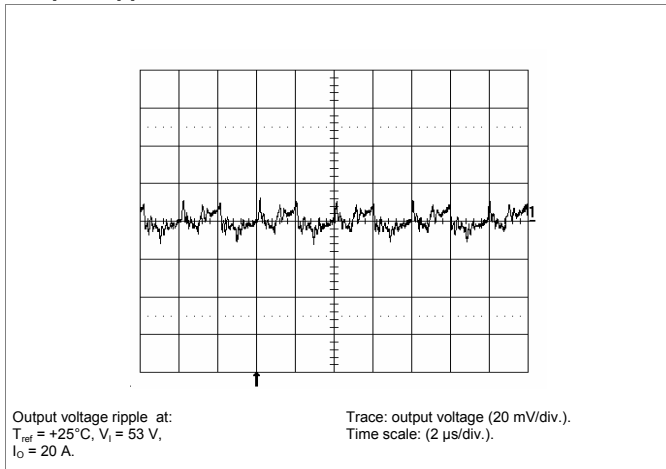

**Output Load Transient Response**

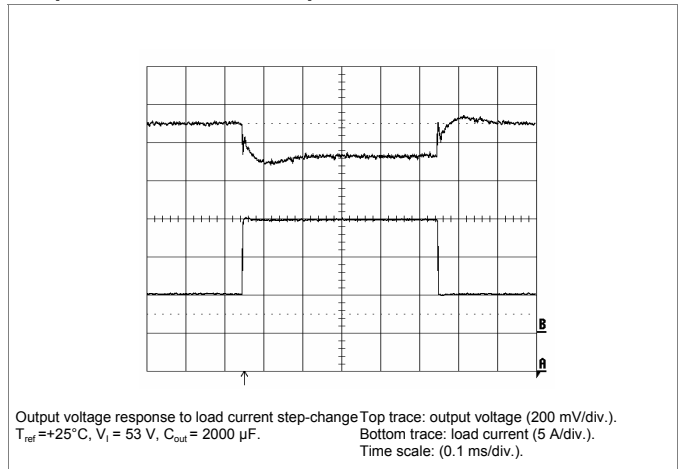

**PKU 4000B PI series Intermediate Bus Converters**  
 Input 36-75 V, Output up to 20 A / 100 W

EN/LZT 146 376 R3B July 2009

© Ericsson AB

**12V, 8.3A / 100 W Electrical Specification**
**PKU 4104B PI**
 $T_{ref} = -40$  to  $+90^{\circ}\text{C}$ ,  $V_I = 36$  to  $75$  V, unless otherwise specified under Conditions.

 Typical values given at:  $T_{ref} = +25^{\circ}\text{C}$ ,  $V_I = 53$  V, max  $I_O$ , unless otherwise specified under Conditions.

| Characteristics |                            | Conditions                        | min | typ  | Max  | Unit          |
|-----------------|----------------------------|-----------------------------------|-----|------|------|---------------|
| $V_I$           | Input voltage range        |                                   | 36  |      | 75   | V             |
| $V_{Ioff}$      | Turn-off input voltage     |                                   | 29  | 30   | 32   | V             |
| $V_{Ion}$       | Turn-on input voltage      |                                   | 30  | 32   | 35   | V             |
| $C_I$           | Internal input capacitance |                                   |     | 3.3  |      | $\mu\text{F}$ |
| $P_O$           | Output power               |                                   | 0   |      | 100  | W             |
| $\eta$          | Efficiency                 | 50 % of max $I_O$                 |     | 92   |      | %             |
|                 |                            | max $I_O$                         |     | 93   |      |               |
|                 |                            | 50 % of max $I_O$ , $V_I = 48$ V  |     | 92.5 |      |               |
|                 |                            | max $I_O$ , $V_I = 48$ V          |     | 93.3 |      |               |
| $P_d$           | Power Dissipation          | max $I_O$                         |     | 7.0  | 10.5 | W             |
| $P_{li}$        | Input idling power         | $I_O = 0$ A, $V_I = 53$ V         |     | 3.2  |      | W             |
| $P_{RC}$        | Input standby power        | $V_I = 53$ V (turned off with RC) |     | 0.1  |      | W             |
| $f_s$           | Switching frequency        | 0-100 % of max $I_O$              |     | 250  |      | kHz           |

|           |  |   |      |           |      |               |
|-----------|--|---|------|-----------|------|---------------|
| $V_{Oi}$  | Output voltage initial setting and accuracy                  | $T_{ref} = +25^{\circ}\text{C}$ , $V_I = 53$ V, 50 % of max $I_O$                               | 11.5 | 12        | 12.5 | V             |
|           | Output voltage tolerance band                                | 0-100 % of max $I_O$  | 10.8 |           | 13.2 | V             |
|           | Idling voltage   | $I_O = 0$ A   | 11.7 |           | 12.9 | V             |
|           | Line regulation  | max $I_O$   |      | 0.2       | 0.65 | V             |
|           | Load regulation  | $V_I = 53$ V, 0-100 % of max $I_O$  |      | 0.7       | 1.0  | V             |
| $V_{tr}$  | Load transient voltage deviation                             | $V_I = 53$ V, Load step 25-75-25 % of max $I_O$ , $di/dt = 5$ A/ $\mu\text{s}$ .<br>See note 1: |      | $\pm 100$ |      | mV            |
| $t_{tr}$  | Load transient recovery time                                 |   |      | 90        |      | $\mu\text{s}$ |
| $t_r$     | Ramp-up time (from 10-90 % of $V_{Oi}$ )                     |   | 4    | 8         | 12   | ms            |
| $t_s$     | Start-up time (from $V_I$ connection to 90 % of $V_{Oi}$ )   |   | 14   | 18        | 24   | ms            |
| $t_f$     | $V_I$ shut-down fall time (from $V_I$ off to 10 % of $V_O$ ) | max $I_O$   |      | 0.1       |      | ms            |
|           |  | $I_O = 0$ % of max $I_O$  |      | 0.9       |      | s             |
| $t_{RC}$  | RC start-up time   | max $I_O$   |      | 17        |      | ms            |
|           | RC shut-down fall time (from RC off to 10 % of $V_O$ )       | max $I_O$   |      | 0.18      |      | ms            |
|           |  | $I_O = 0$ % of max $I_O$  |      | 1         |      | s             |
| $I_O$     | Output current   |   | 0    |           | 8.3  | A             |
| $I_{lim}$ | Current limit threshold                                      | $T_{ref} < \text{max } T_{ref}$   |      | 14        |      | A             |
| $I_{sc}$  | Short circuit current  | $T_{ref} = 25^{\circ}\text{C}$  |      | 18        |      | A             |
| $V_{Oac}$ | Output ripple & noise  | See ripple & noise section, max $I_O$ , $V_{Oi}$  |      | 50        | 100  | mVp-p         |
| OVP       | Over voltage protection                                      | $T_{ref} = +25^{\circ}\text{C}$ , $V_I = 53$ V, 0-100 % of max $I_O$                            |      | 13.4      |      | V             |

 Note 1: Capacitance on the output is 1000  $\mu\text{F}$  (ceramics, ESR approx 5 m $\Omega$ )



**PKU 4000B PI series Intermediate Bus Converters**  
 Input 36-75 V, Output up to 20 A / 100 W

EN/LZT 146 376 R3B July 2009

© Ericsson AB

**12V, 8.3A / 100W Typical Characteristics**

**PKU 4104B PI**

**Efficiency**

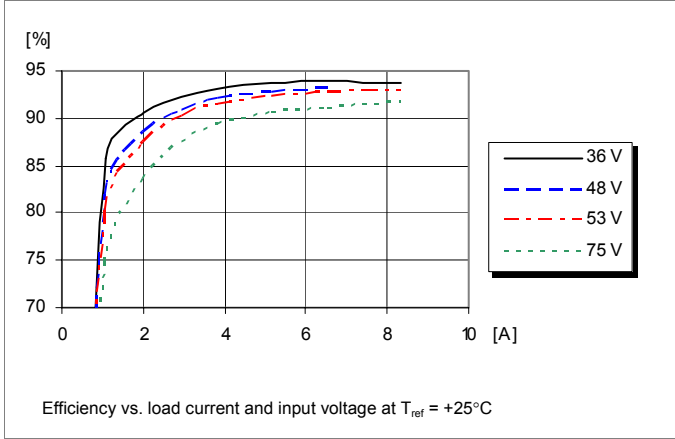

**Power Dissipation**

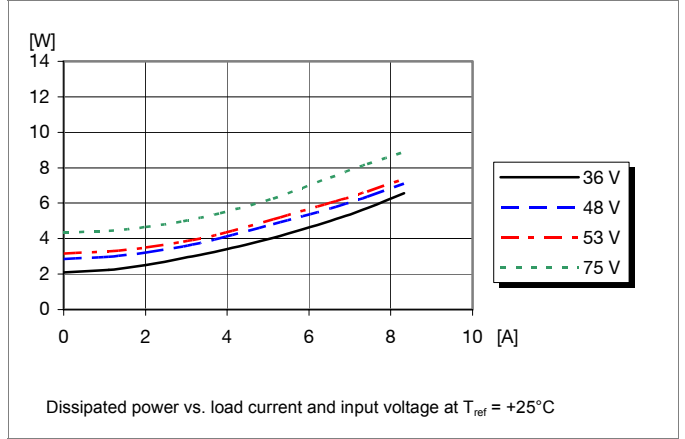

**Output Current Derating**

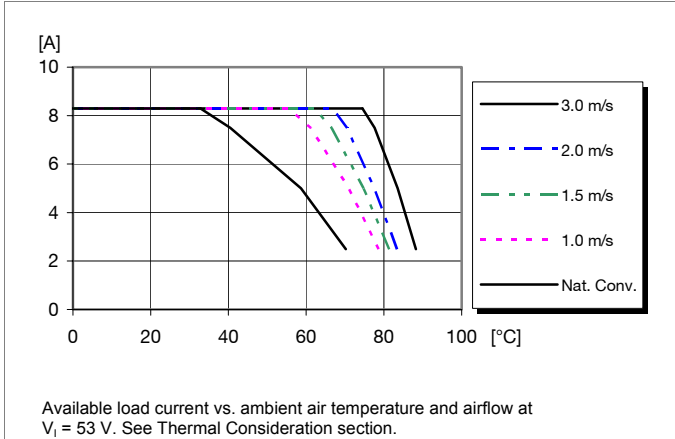

**Output Characteristics**

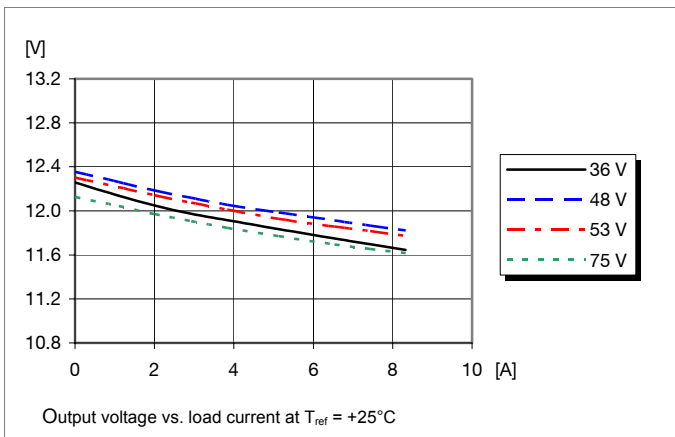

**Current Limit Characteristics**

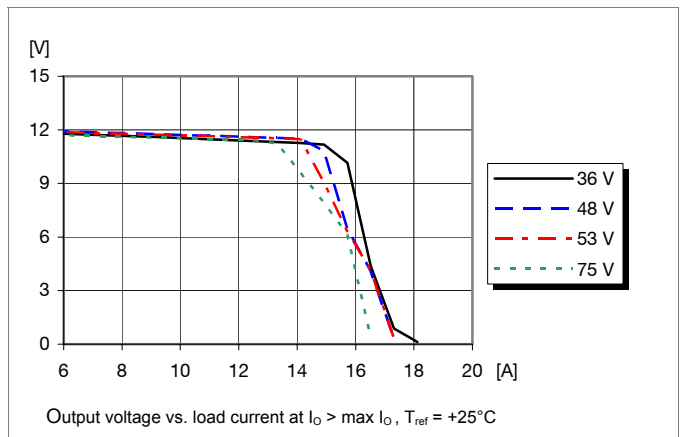

**PKU 4000B PI series Intermediate Bus Converters**  
 Input 36-75 V, Output up to 20 A / 100 W

EN/LZT 146 376 R3B July 2009

© Ericsson AB

**12V, 8.3A / 100W Typical Characteristics**

**PKU 4104B PI**

**Start-up**

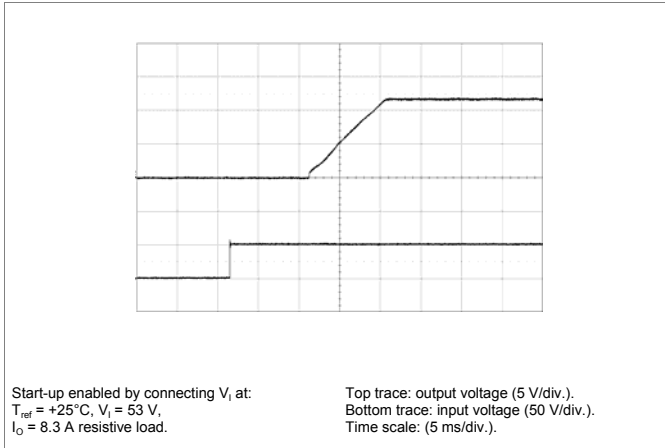

**Shut-down**

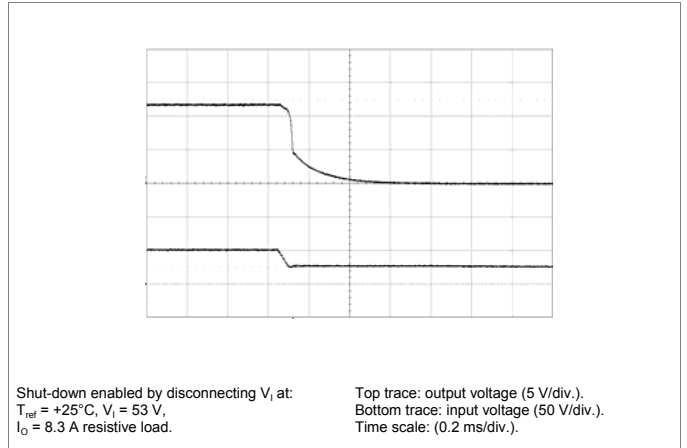

**Output Ripple & Noise**

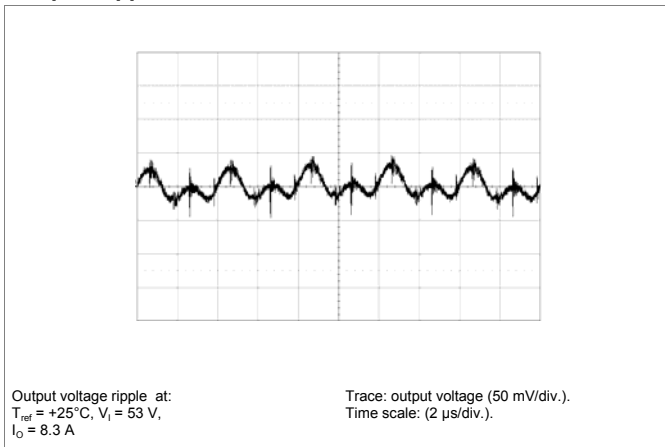

**Output Load Transient Response**

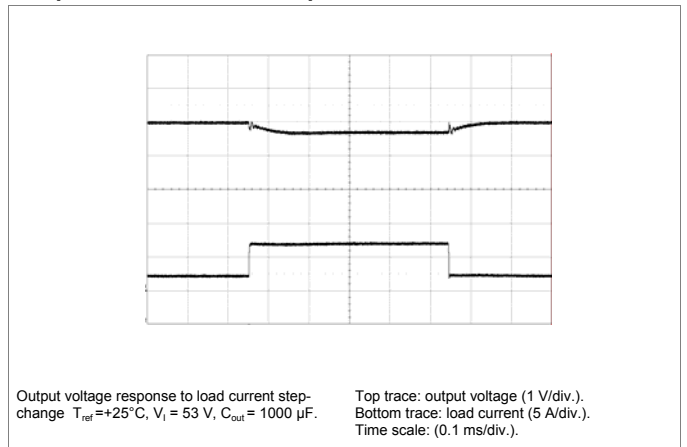

**PKU 4000B PI series Intermediate Bus Converters**  
 Input 36-75 V, Output up to 20 A / 100 W

EN/LZT 146 376 R3B July 2009

© Ericsson AB

**EMC Specification**

Conducted EMI measured according to EN55022, CISPR 22 and FCC part 15J (see test set-up). See Design Note 009 for further information. The fundamental switching frequency is 250 kHz for PKU 4101B.

**Conducted EMI Input terminal value (typ)**

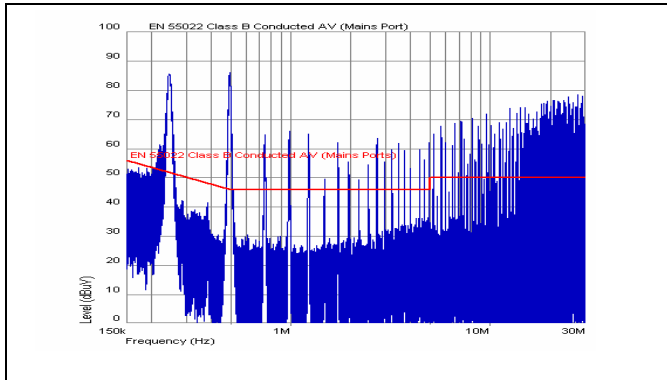

EMI without filter @  $V_i = 48\text{ V}$ , max  $I_o$ .

**External filter (class B)**

Required external input filter in order to meet class B in EN 55022, CISPR 22 and FCC part 15J.

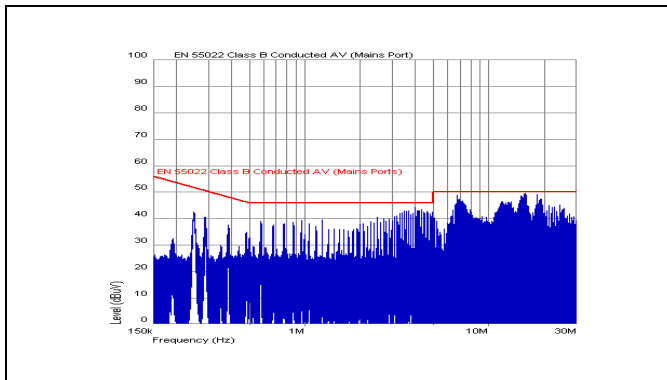
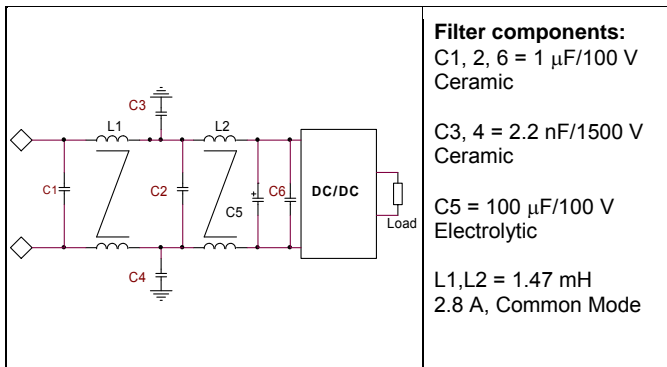

EMI with filter @  $V_i = 48\text{ V}$ , max  $I_o$ .

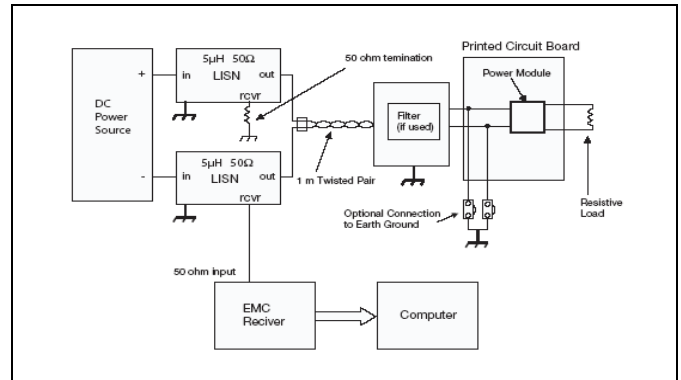

Test set-up

**Layout recommendation**

The radiated EMI performance of the DC/DC converter will depend on the PCB layout and ground layer design. It is also important to consider the stand-off of the DC/DC converter. With regards to the isolation requirements avoid placing a conductor which is connected to the primary side below the DC/DC converter. If a ground layer is used, it should be connected to the output of the DC/DC converter and the equipment ground or chassis.

A ground layer will increase the stray capacitance in the PCB and improve the high frequency EMC performance.

**Output ripple and noise**

Output ripple and noise measured according to figure below. See Design Note 022 for detailed information.

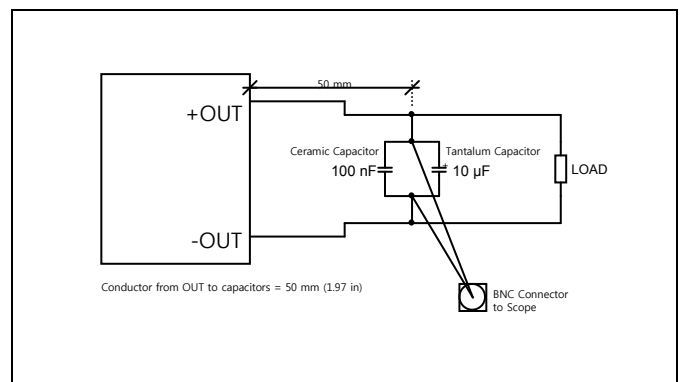

Output ripple and noise test setup

**PKU 4000B PI series Intermediate Bus Converters**  
Input 36-75 V, Output up to 20 A / 100 W

EN/LZT 146 376 R3B July 2009

© Ericsson AB

**Operating information****Input Voltage**

The input voltage range 36 to 75 Vdc meets the requirements of the European Telecom Standard ETS 300 132-2 for normal input voltage range in -48 and -60 Vdc systems, -40.5 to -57.0 V and -50.0 to -72 V respectively.  
The absolute maximum continuous input voltage is 80 Vdc.

**Turn-off Input Voltage**

The DC/DC converters monitor the input voltage and will turn on and turn off at predetermined levels.  
The minimum hysteresis between turn on and turn off input voltage is 1 V.

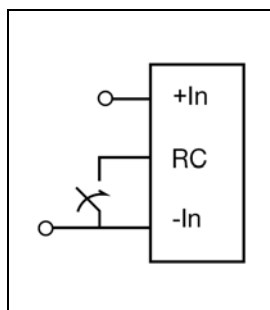
**Remote Control (RC)**

The products are fitted with a remote control function referenced to the primary negative input connection (- In), with negative and positive logic options available. The RC function allows the converter to be turned on/off by an external device like a semiconductor or mechanical switch. The RC pin has an internal pull up resistor to + In.

The maximum required sink current is 0.4 mA. When the RC pin is left open, the voltage generated on the RC pin is max 5 V. The maximum allowable leakage current of the switch is 50  $\mu$ A. With "negative logic" the converter will turn on when the input voltage is applied with the RC connected to the - In. Turn off is achieved by leaving the RC pin open, or connected to a voltage higher than 5 V referenced to -In.

The second option is "positive logic" remote control, which can be ordered by adding the suffix "P" to the end of the part number. The converter will turn on when the input voltage is applied with the RC pin open. Turn off is achieved by connecting the RC pin to the - In. To ensure safe turn off the voltage difference between RC pin and the - In pin shall be less than 1 V. The converter will restart automatically when this connection is opened.

**Input and Output Impedance**

The impedance of both the input source and the load will interact with the impedance of the DC/DC converter. It is important that the input source has low characteristic impedance. The converters are designed for stable operation without external capacitors connected to the output. The performance in some applications can be enhanced by addition of external capacitance as described under External Decoupling Capacitors. If the input voltage source contains significant inductance, the addition of a 100  $\mu$ F capacitor across the input of the converter will ensure stable operation. The capacitor is not required when powering the DC/DC converter from an input source with an inductance below 10  $\mu$ H.

**External Decoupling Capacitors**

When powering loads with significant dynamic current requirements, the voltage regulation at the point of load can be improved by addition of decoupling capacitors at the load. The most effective technique is to locate low ESR ceramic and electrolytic capacitors as close to the load as possible, using several parallel capacitors to lower the effective ESR. The ceramic capacitors will handle high-frequency dynamic load changes while the electrolytic capacitors are used to handle low frequency dynamic load changes. Ceramic capacitors will also reduce any high frequency noise at the load. It is equally important to use low resistance and low inductance PCB layouts and cabling.

For further information please contact your local Ericsson Power Modules representative.

**Parallel Operation**

Two converters may be paralleled for redundancy (1+1) if the total power is equal or less than P<sub>Omax</sub> for one unit. To secure the function o-ring diodes may be used.

**Pre-bias Start-up**

These products has pre-bias start up functionality and will not sink current during start up if a pre-bias source is present at the output terminal up to the min-value of output voltage tolerance band, i.e 4.5 V for a 5 V version and 10.8 V for a 12 V version. Nor will there be any under or over shoot.

See Design Note 026 for detailed information.

**Over Temperature Protection (OTP)**

The converters are protected from thermal overload by an internal over temperature shutdown circuit. When T<sub>ref</sub> as defined in thermal consideration section exceeds 135°C the converter will shut down. The DC/DC converter will resume normal operation automatically when the temperature has dropped approx 22°C below the temperature threshold.

**Over Voltage Protection (OVP)**

The converters have output over voltage protection that will clamp the output voltage to a continuous fixed level. After removal of the over voltage condition the converter will resume to normal operation automatically.

**Over Current Protection (OCP)**

The converters include current limiting circuitry for protection at continuous overload. The output voltage will decrease towards zero for output currents in excess of max output current (max I<sub>O</sub>). The DC/DC converter will resume normal operation after removal of the overload. The load distribution should be designed for the maximum output short circuit current specified.

**PKU 4000B PI series Intermediate Bus Converters**  
 Input 36-75 V, Output up to 20 A / 100 W

EN/LZT 146 376 R3B July 2009

© Ericsson AB

**Thermal Consideration**

**General**

The converters are designed to operate in different thermal environments and sufficient cooling must be provided to ensure reliable operation. Cooling is achieved mainly by conduction, from the pins to the host board, and convection, which is dependent on the airflow across the converter. Increased airflow enhances the cooling of the converter.

The Output Current Derating graph found in the Output section for each model provides the available output current vs. ambient air temperature and air velocity at  $V_{in} = 53 V$ .

The DC/DC converter is tested on a 254 x 254 mm, 35  $\mu m$  (1 oz), 16-layer test board mounted vertically in a wind tunnel with a cross-section of 305 x 305 mm.

Proper cooling of the DC/DC converter can be verified by measuring the temperature at reference point. The temperature at this position should not exceed the max values provided in the table below.

See Design Note 019 for further information.

**Connections**

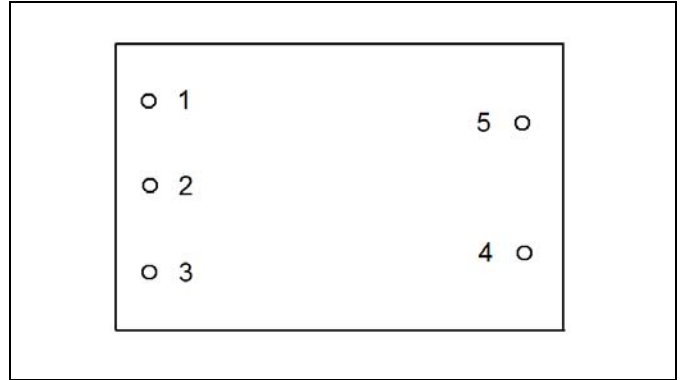

Top View

| Pin | Designation | Function        |
|-----|-------------|-----------------|
| 1   | +In         | Positive Input  |
| 2   | RC          | Remote Control  |
| 3   | -In         | Negative Input  |
| 4   | -Out        | Negative Output |
| 5   | +Out        | Positive Output |

| Position  | Device   | Designation | Max value |
|-----------|----------|-------------|-----------|
| Reference | 4101B PI | $T_{ref}$   | 120°C     |
| Reference | 4104B PI | $T_{ref}$   | 115°C     |

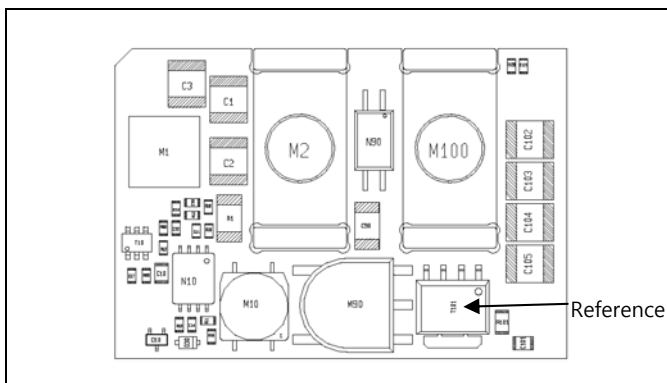

**Definition of reference temperature ( $T_{ref}$ )**

The reference temperature is used to monitor the temperature limits of the product. Temperatures above maximum  $T_{ref}$  are not allowed and may cause degradation or permanent damage to the product.  $T_{ref}$  is also used to define the temperature range for normal operating conditions.  $T_{ref}$  is defined by the design and used to guarantee safety margins, proper operation and high reliability of the module.

**PKU 4000B PI series Intermediate Bus Converters**  
 Input 36-75 V, Output up to 20 A / 100 W

EN/LZT 146 376 R3B July 2009

© Ericsson AB

**Mechanical Information- Surface mount version**

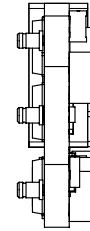
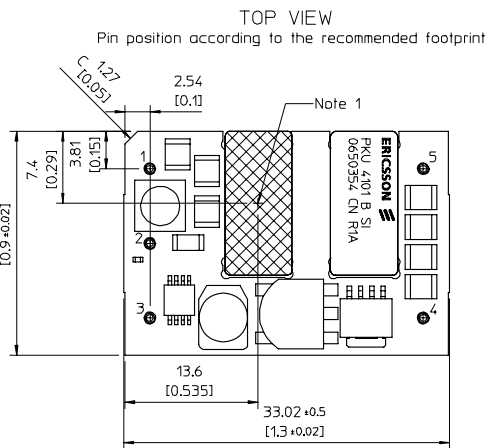
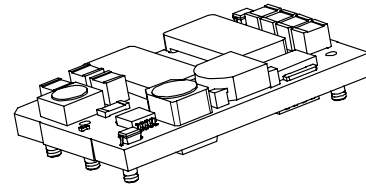
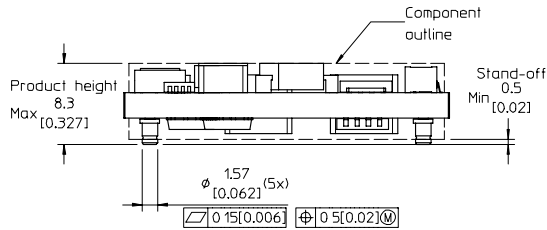

RECOMMENDED FOOTPRINT - TOP VIEW

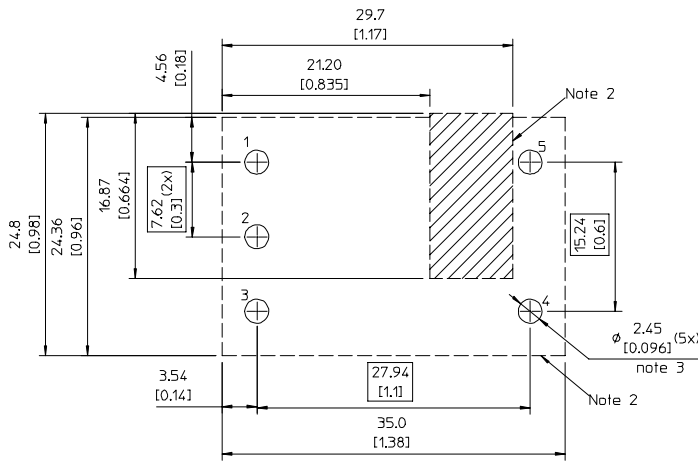

- Note 1: Pick up surface area 6.7 x 14.5 mm.  
 Cross is the center of pick up area.
- Note 2: Recommended keep away area for user components.  
 Hatch area is under the output ferrite.  
 Do not place components, conductive parts or open vias connected to input circuit in this area. Open vias are allowed if there is a common input and output ground on the board, i.e. two-wire system.
- Note 3: Use sufficient numbers of vias connected output pin pads for optimal thermal and current conductivity.

Weight: Typical 13.5 g

Pins:  
 Material: Copper alloy  
 Plating: Min 0.1  $\mu$ m Gold over 1-3  $\mu$ m Nickel



All dimensions in mm [inch].  
 Tolerances unless specified  
 x.x mm  $\pm$ 0.5 mm [0.02]  
 x.xx mm  $\pm$ 0.25 mm [0.01]  
 (Not applied on the recommended footprint)

**PKU 400B PI series Intermediate Bus Converters**  
 Input 36-75 V, Output up to 20 A / 100 W

EN/LZT 146 376 R3B July 2009

© Ericsson AB

**Mechanical Information- Hole mount version**

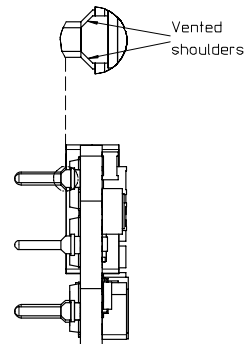
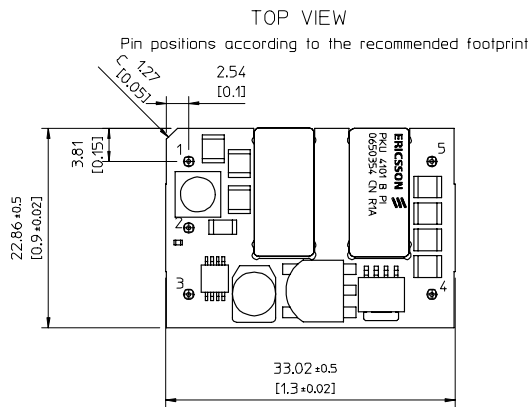
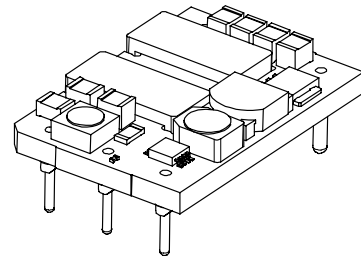
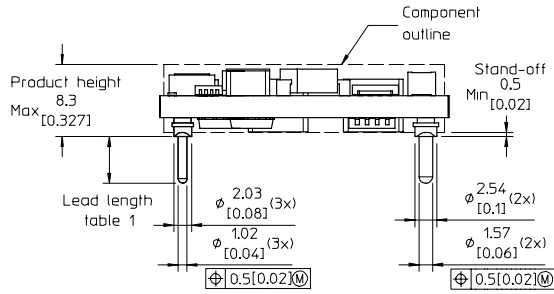

RECOMMENDED FOOTPRINT -TOP VIEW

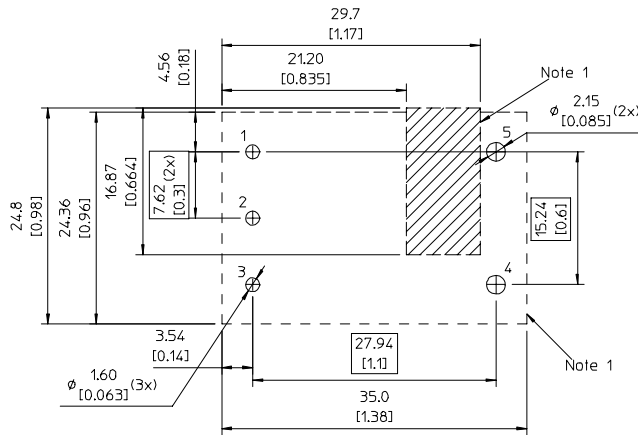

Table 1

| Pin Option | Lead Length        |
|------------|--------------------|
| Standard   | 5.33 [0.210]       |
| LA         | 3.69 [0.145] (cut) |
| LB         | 4.57 [0.180] (cut) |

Weight: Typical 14 g

Pins:  
 Material: Copper alloy  
 Plating: Min 0.1 μm Gold over 1-3 μm Nickel

Note 1: Recommended keep away area for user components.  
 Hatch area is under the output ferrite.  
 Do not place components, conductive parts or open vias connected to input circuit in this area. Open vias are allowed if there is a common input and output ground on the board, i.e. two-wire system.



All dimensions in mm [inch].  
 Tolerances unless specified  
 x.x mm ±0.5 mm [0.02]  
 x.xx mm ±0.25 mm [0.01]  
 (Not applied on the recommended footprint)

**PKU 4000B PI series Intermediate Bus Converters**  
 Input 36-75 V, Output up to 20 A / 100 W

EN/LZT 146 376 R3B July 2009

© Ericsson AB

**Soldering Information - Surface Mounting**

The surface mount product is intended for forced convection or vapor phase reflow soldering in SnPb or Pb-free processes.

The reflow profile should be optimised to avoid excessive heating of the product. It is recommended to have a sufficiently extended preheat time to ensure an even temperature across the host PCB and it is also recommended to minimize the time in reflow.

A no-clean flux is recommended to avoid entrapment of cleaning fluids in cavities inside the product or between the product and the host board, since cleaning residues may affect long time reliability and isolation voltage.

**Minimum Pin Temperature Recommendations**

Pin number 5 is chosen as reference location for the minimum pin temperature recommendation since this will likely be the coolest solder joint during the reflow process.

**SnPb solder processes**

For SnPb solder processes, a pin temperature ( $T_{PIN}$ ) in excess of the solder melting temperature, ( $T_L$ , 183°C for Sn63Pb37) for more than 30 seconds and a peak temperature of 210°C is recommended to ensure a reliable solder joint.

**Lead-free (Pb-free) solder processes**

For Pb-free solder processes, a pin temperature ( $T_{PIN}$ ) in excess of the solder melting temperature ( $T_L$ , 217 to 221°C for SnAgCu solder alloys) for more than 30 seconds and a peak temperature of 235°C on all solder joints is recommended to ensure a reliable solder joint.

**Maximum Product Temperature Requirements**

Top of the product PCB near pin 2 is chosen as reference location for the maximum (peak) allowed product temperature ( $T_{PRODUCT}$ ) since this will likely be the warmest part of the product during the reflow process.

**SnPb solder processes**

For SnPb solder processes, the product is qualified for MSL 1 according to IPC/JEDEC standard J-STD-020C.

During reflow  $T_{PRODUCT}$  must not exceed 225 °C at any time.

**Pb-free solder processes**

For Pb-free solder processes, the product is qualified for MSL 3 according to IPC/JEDEC standard J-STD-020C.

During reflow  $T_{PRODUCT}$  must not exceed 260 °C at any time.

**Dry Pack Information**

Products intended for Pb-free reflow soldering processes are delivered in standard moisture barrier bags according to IPC/JEDEC standard J-STD-033 (Handling, packing, shipping and use of moisture/reflow sensitivity surface mount devices).

Using products in high temperature Pb-free soldering processes requires dry pack storage and handling. In case the products have been stored in an uncontrolled environment and no longer can be considered dry, the modules must be baked according to J-STD-033.

**Thermocoupler Attachment**

| General reflow process specifications         | SnPb eutectic       | Pb-free   |
|---|---------------------|-----------|
| Average ramp-up ( $T_{PRODUCT}$ )             | 3°C/s max           | 3°C/s max |
| Typical solder melting (liquidus) temperature | $T_L$ 183°C         | 221°C     |
| Minimum reflow time above $T_L$               | 30 s                | 30 s      |
| Minimum pin temperature                       | $T_{PIN}$ 210°C     | 235°C     |
| Peak product temperature                      | $T_{PRODUCT}$ 225°C | 260°C     |
| Average ramp-down ( $T_{PRODUCT}$ )           | 6°C/s max           | 6°C/s max |
| Maximum time 25°C to peak                     | 6 minutes           | 8 minutes |

Pin 5 for measurement of minimum pin (solder joint) temperature,  $T_{PIN}$

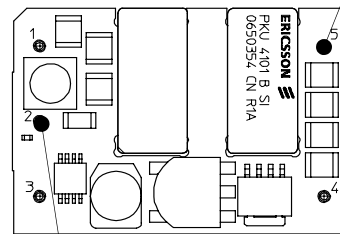

Pin 2 for measurement of maximum product temperature,  $T_{PRODUCT}$

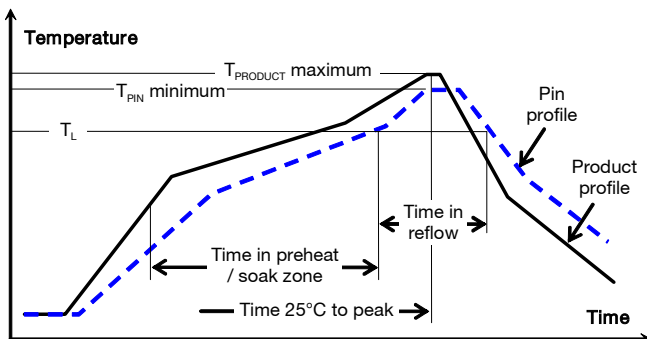



**PKU 4000B PI series Intermediate Bus Converters**  
 Input 36-75 V, Output up to 20 A / 100 W

EN/LZT 146 376 R3B July 2009  
 © Ericsson AB

**Soldering Information - Hole Mounting**

The hole mounted product is intended for plated through hole mounting by wave or manual soldering. The pin temperature is specified to maximum 270°C for maximum 10 seconds.

A maximum preheat rate of 4°C/s and maximum preheat temperature of 150°C is suggested. When soldering by hand, care should be taken to avoid direct contact between the hot soldering iron tip and the pins for more than a few seconds in order to prevent overheating.

A no-clean flux is recommended to avoid entrapment of cleaning fluids in cavities inside the product or between the product and the host board. The cleaning residues may affect long time reliability and isolation voltage.

**Delivery Package Information**

The surface mount products are delivered in antistatic injection molded trays (Jedec design guide 4.10D standard) and in antistatic carrier tape (EIA 481 standard). The through-hole mount products are delivered in antistatic injection molded trays (Jedec design guide 4.10D standard).

| Tray Specifications       |   |
|---------------------------|---|
| <b>Material</b>           | Antistatic PPE  |
| <b>Surface resistance</b> | $10^5 < \text{Ohm/square} < 10^{12}$                  |
| <b>Bakability</b>         | The trays can be baked at maximum 125°C for 48 hours] |
| <b>Tray thickness</b>     | 18.5 mm [0.728 inch]                                  |
| <b>Box capacity</b>       | 150 products (5 full trays/box)                       |
| <b>Tray weight</b>        | 190 g empty, 600 g full tray                          |

| Carrier Tape Specifications        |                             |
|------------------------------------|-----------------------------|
| <b>Material</b>                    | Antistatic PS               |
| <b>Surface resistance</b>          | $< 10^7 \text{ Ohm/square}$ |
| <b>Bakeability</b>                 | The tape is not bakable     |
| <b>Tape width, W</b>               | 56 mm [2.2 inch]            |
| <b>Pocket pitch, P<sub>1</sub></b> | 36 mm [1.42 inch]           |
| <b>Pocket depth, K<sub>0</sub></b> | 8.7 mm [0.343 inch]         |
| <b>Reel diameter</b>               | 380 mm [15 inch]            |
| <b>Reel capacity</b>               | 200 products /reel          |
| <b>Reel weight</b>                 | Rounded 3 kg/full reel      |

EIA standard carrier tape

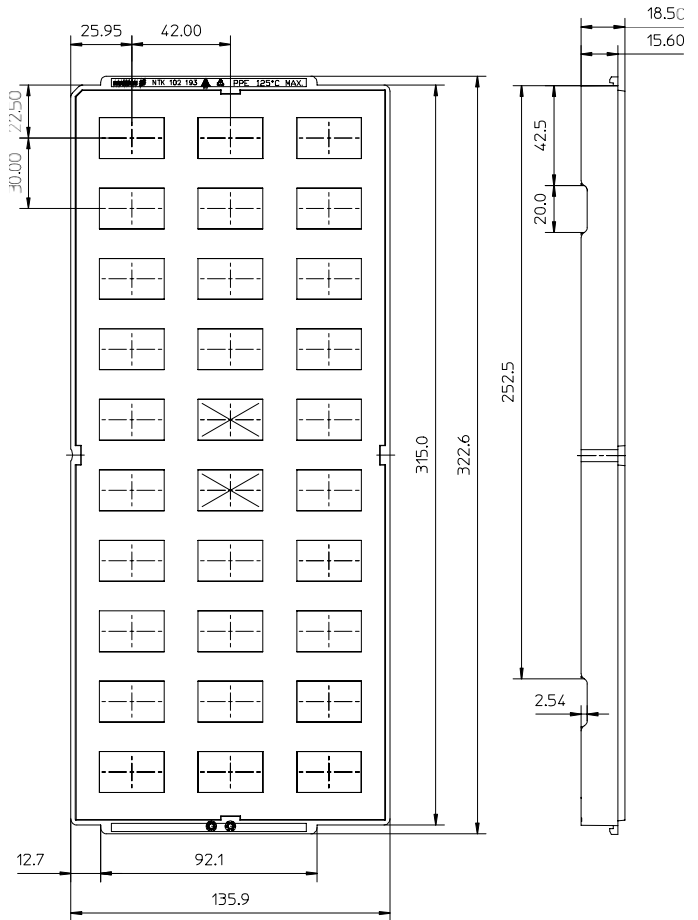
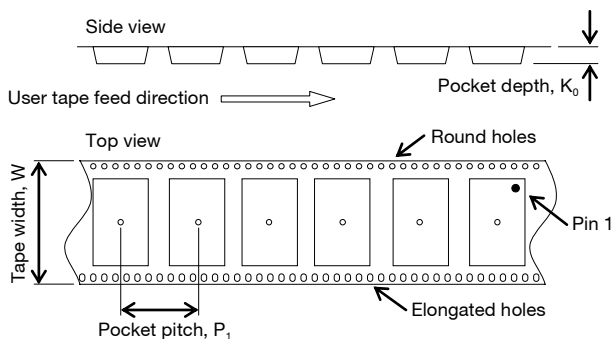

X= Vacuum pickup area  
 All dimensions in mm [inch]  
 Tolerances: X.xx mm ±0.13 mm [0.005], X.x mm ±0.26 mm [0.01]  
 Note: tray dimensions refer to pocket center. For exact location of product pickup surface, refer to mechanical drawing.

**PKU 4000B PI series Intermediate Bus Converters**  
 Input 36-75 V, Output up to 20 A / 100 W

EN/LZT 146 376 R3B July 2009

© Ericsson AB

**Product Qualification Specification**

| Characteristics                             |  |   |   |
|---|--|---|---|
| External visual inspection                  | IPC-A-610  |   |   |
| Change of temperature (Temperature cycling) | IEC 60068-2-14 Na  | Temperature range<br>Number of cycles<br>Dwell/transfer time          | -40 to 100°C<br>1000<br>15 min/0-1 min                              |
| Cold (in operation)                         | IEC 60068-2-1 Ad   | Temperature T <sub>A</sub><br>Duration                                | -45°C<br>72 h   |
| Damp heat                                   | IEC 60068-2-67 Cy  | Temperature<br>Humidity<br>Duration                                   | 85°C<br>85 % RH<br>1000 hours                                       |
| Dry heat                                    | IEC 60068-2-2 Bd   | Temperature<br>Duration   | 125°C<br>1000 h   |
| Electrostatic discharge susceptibility      | IEC 61340-3-1, JESD 22-A114<br>IEC 61340-3-2, JESD 22-A115 | Human body model (HBM)<br>Machine Model (MM)                          | Class 2, 2000 V<br>Class 3, 200 V                                   |
| Immersion in cleaning solvents              | IEC 60068-2-45 XA, method 2                                | Water<br>Glycol ether<br>Isopropyl alcohol                            | 55°C<br>35°C<br>35°C  |
| Mechanical shock                            | IEC 60068-2-27 Ea  | Peak acceleration<br>Duration   | 100 g<br>6 ms   |
| Moisture reflow sensitivity <sup>1</sup>    | J-STD-020C   | Level 1 (SnPb-eutectic)<br>Level 3 (Pb Free)                          | 225°C<br>260°C  |
| Operational life test                       | MIL-STD-202G, method 108A                                  | Duration  | 1000 h  |
| Resistance to soldering heat <sup>2</sup>   | IEC 60068-2-20 Tb, method 1A                               | Solder temperature<br>Duration  | 270°C<br>10-13 s  |
| Robustness of terminations                  | IEC 60068-2-21 Test Ua1<br>IEC 60068-2-21 Test Ue1         | Through hole mount products<br>Surface mount products                 | All leads<br>All leads  |
| Solderability                               | IEC 60068-2-58 test Td <sup>1</sup>                        | Preconditioning<br>Temperature, SnPb Eutectic<br>Temperature, Pb-free | 150°C dry bake 16 h<br>215°C<br>235°C                               |
|   | IEC 60068-2-20 test Ta <sup>2</sup>                        | Preconditioning<br>Temperature, SnPb Eutectic<br>Temperature, Pb-free | Steam ageing<br>235°C<br>245°C                                      |
| Vibration, broad band random                | IEC 60068-2-64 Fh, method 1                                | Frequency<br>Spectral density<br>Duration                             | 10 to 500 Hz<br>0.07 g <sup>2</sup> /Hz<br>10 min in each direction |

**Notes**
<sup>1</sup> Only for products intended for reflow soldering (surface mount products)

<sup>2</sup> Only for products intended for wave soldering (plated through hole products)