



Data Sheet

M-FIAM5B

Military COTS 28 Vin Filter Input Attenuator Module

Model Number: M-FIAM5BM21*



M-FIAM5B:
2.28 x 2.2 x 0.5 in
57,9 x 55,9 x 12,7 mm

Features

- EMI filtering-MIL-STD-461E⁽¹⁾
- Transient protection-MIL-STD-704E/F
- Environments-MIL-STD-810, MIL-STD-202
- Environmental stress screening
- Low profile mounting options
- Output power up to 560 W
- Output current up to 20 A
- Mini sized package
- Inrush current limiting

Product Highlights

The M-FIAM5B is a DC front-end module that provides EMI filtering and transient protection. The M-FIAM5B enables designers using Vicor's Maxi, Mini, Micro Series 24 V DC-DC converters to meet conducted emission / conducted susceptibility per MIL-STD-461E; and input transients per MIL-STD-704E/F. The M-FIAM5B accepts an input voltage of 14 – 36 Vdc and delivers output current up to 20 A.

M-FIAM5B is housed in an industry standard "half brick" module measuring 2.28" x 2.2" x 0.5" and depending upon model selected, may be mounted onboard or inboard for height critical applications.

Compatible Products

- Maxi, Mini, Micro Series 24 V Input DC-DC converters
- 24 V Input VIPAC Arrays

⁽¹⁾EMI performance is subject to a wide variety of external influences such as PCB construction, circuit layout etc. As such, external components in addition to those listed herein may be required in specific instances to gain full compliance to the standards specified.

Absolute Maximum Rating

Parameter	Rating	Unit	Notes
+In to -In	36	Vdc	Continuous
	50	Vdc	12.5 ms, See Fig.3
Mounting torque	5 (0.57)	in-lbs	6 each, #4-40 or M3
Pin soldering temperature	500 (260)	°F(°C)	<5 sec; wave solder
	750 (390)	°F(°C)	<7 sec; hand solder

Thermal Resistance and Capacity

Parameter	Min	Typ	Max	Unit
Baseplate to sink				
	flat, greased surface		0.16	°C/Watt
	with thermal pad (P/N 20264)		0.1	°C/Watt
Baseplate to ambient				
	Free convection		7.9	°C/Watt
1000 LFM		2.2	°C/Watt	

MTBF per MIL-HDBK-217F (M-FIAM5BM21)

Temperature	Environment	MTBF	Unit
25°C	Ground Benign: G.B.	2,533	1,000 Hrs
50°C	Naval Sheltered: N.S.	456	1,000 Hrs
65°C	Airborne Inhabited Cargo: A.I.C.	375	1,000 Hrs

Part Numbering*

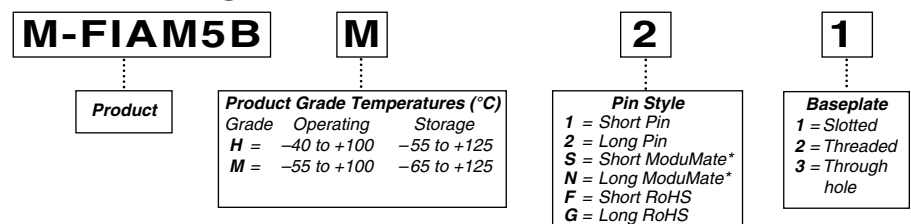

*Compatible with SurfMate and InMate socketing system.

SPECIFICATIONS

(typical at $T_{BP} = 25^{\circ}\text{C}$, nominal line and 75% load, unless otherwise specified)

INPUT SPECIFICATIONS

Parameter	Min	Typ	Max	Unit	Notes
Input voltage	14	28	36	Vdc	Continuous
Inrush limiting			0.007	A/ μF	
Transient immunity			50	Vdc	12.5 ms per MIL-STD-704E/F, continuous operation

OUTPUT SPECIFICATIONS

Parameter	Min	Typ	Max	Unit	Notes
Output current			20	A	
Output power			560	W	
Efficiency	96	98		%	
Internal voltage drop		0.5	0.7	Vdc	@20 A, 100°C baseplate
External capacitance	330		1000	μF	See Figure 5 on page 4 50 V

CONTROL PIN SPECIFICATIONS

Parameter	Min	Typ	Max	Unit	Notes
ON/OFF control					
Enable (ON)	0.0		1.0	Vdc	Referenced to – Vout
Disable (OFF)	3.5		5.0	Vdc	100 k Ω internal pull up resistor

SAFETY SPECIFICATIONS

Parameter	Min	Typ	Max	Unit	Notes
Dielectric withstand		1,500	Vrms		Input / Output to Base
		2,121	Vdc		Input / Output to Base

EMI

Standard	Test Procedure	Notes
MIL-STD-461E		
Conducted emissions:	CE101, CE102	
Conducted susceptibility:	CS101, CS114, CS115, CS116	

EMI performance is subject to a wide variety of external influences such as PCB construction, circuit layout etc. As such, external components in addition to those listed herein may be required in specific instances to gain full compliance to the standards specified.

GENERAL SPECIFICATIONS

Parameter	Min	Typ	Max	Unit	Notes
Weight			3.3 (94)	Ounces (grams)	
Warranty			2	Years	

SPECIFICATIONS (CONT.)

■ ENVIRONMENTAL QUALIFICATION

Altitude	MIL-STD-810F, Method 500.4, Procedure I & II, 40,000 ft. and 70,000 ft. Operational.
Explosive Atmosphere	MIL-STD-810F, Method 511.4, Procedure I, Operational.
Vibration	MIL-STD-810F, Method 514.5, Procedure I, Category 14, Sine and Random vibration per Table 514.5C for Helicopter AH-6J Main Rotor with overall level of 5.6 G rms for 4 hours per axis. MIL-STD-810F, Method 514.5C, General Minimum Integrity Curve per Figure 514.5C-17 with overall level of 7.7 G rms for 1 hour per axis.
Shock	MIL-STD-810F, Method 516.5, Procedure I, Functional Shock, 40 g. MIL-S-901D, Lightweight Hammer Shock, 3 impacts/axis, 1,3,5 ft. MIL-STD-202F, Method 213B, 60 g, 9 ms half sine. MIL-STD-202F, Method 213B, 75 g, 11 ms Saw Tooth Shock.
Acceleration	MIL-STD-810F, Method 513.5, Procedure II, table 513.5-II, Operational, 2-7 g, 6 directions.
Humidity	MIL-STD-810F, Method 507.4.
Solder Test	MIL-STD-202G, Method 208H, 8 hour aging.

■ ENVIRONMENTAL STRESS SCREENING

Parameter	H-Grade	M-Grade
Operating temperature	-40°C to +100°C	-55°C to +100°C
Storage temperature	-55°C to +125°C	-65°C to +125°C
Temperature cycling*	12 cycles -65°C to +100°C	12 cycles -65°C to +100°C
Ambient test @ 25°C	Yes	Yes
Power cycling burn-in	12 hours, 29 cycles	24 hours, 58 cycles
Functional and parametric ATE tests	-40°C and +100°C	-55°C and +100°C
Hi-Pot test	Yes	Yes
Visual inspection	Yes	Yes
Test data	vicorpower.com	vicorpower.com

*Temperature cycled with power off, 17°C per minute rate of change.

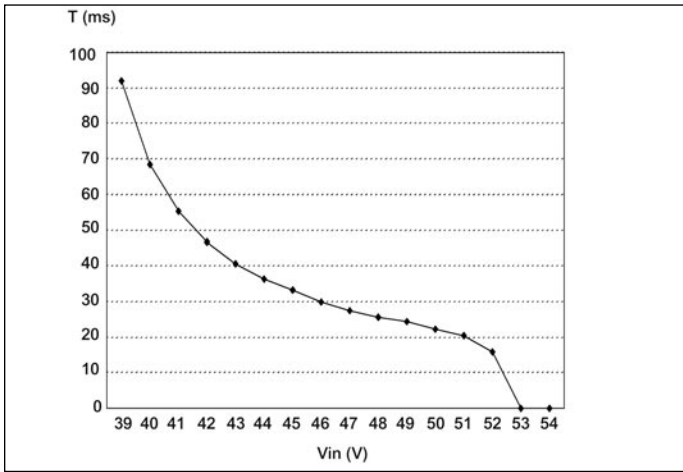

Figure 1 — Shut Down Time of M-FIAM5B vs. Overvoltage

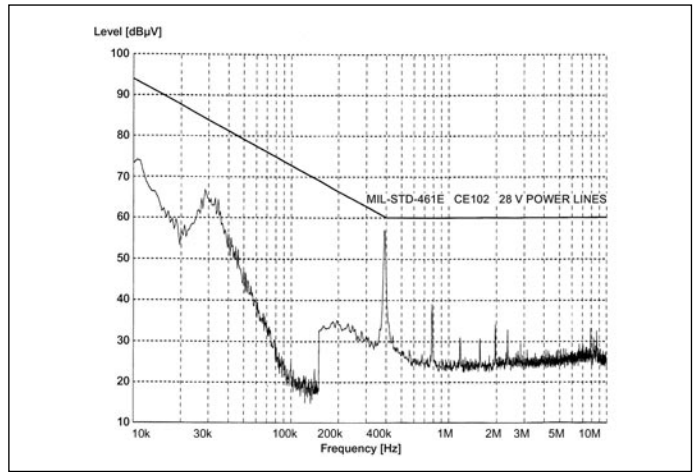

Figure 2 — Conducted Noise; M-FIAM5B and Model V24A12M400B DC-DC converter operating at 28 Vdc, 400 W.

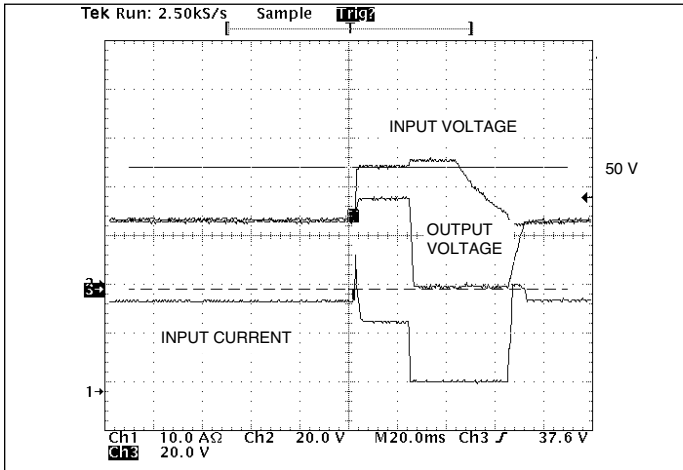

Figure 3 — Transient Immunity: M-FIAM5B output response to an input transient.

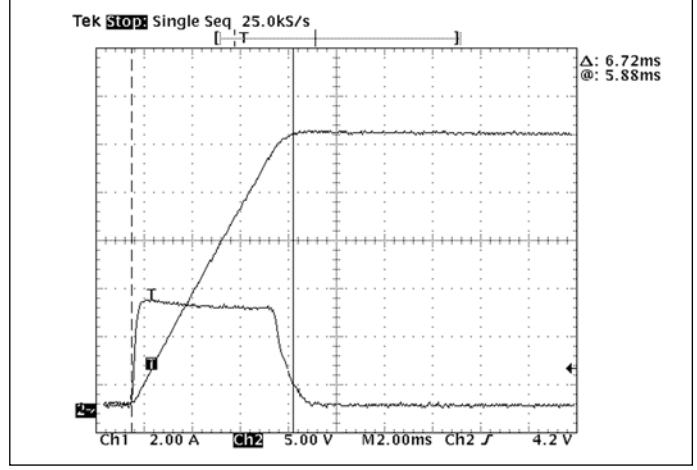

Figure 4— Inrush Limiting: Inrush current with 1000 μ F external capacitance, (C1 in Figure 5)

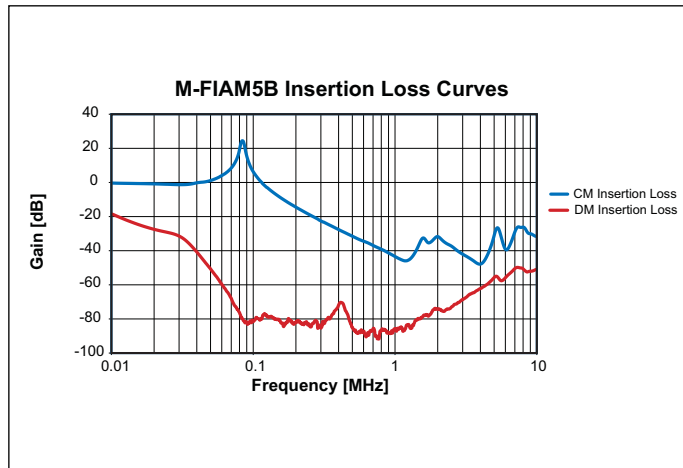

Figure 5 — Insertion Loss

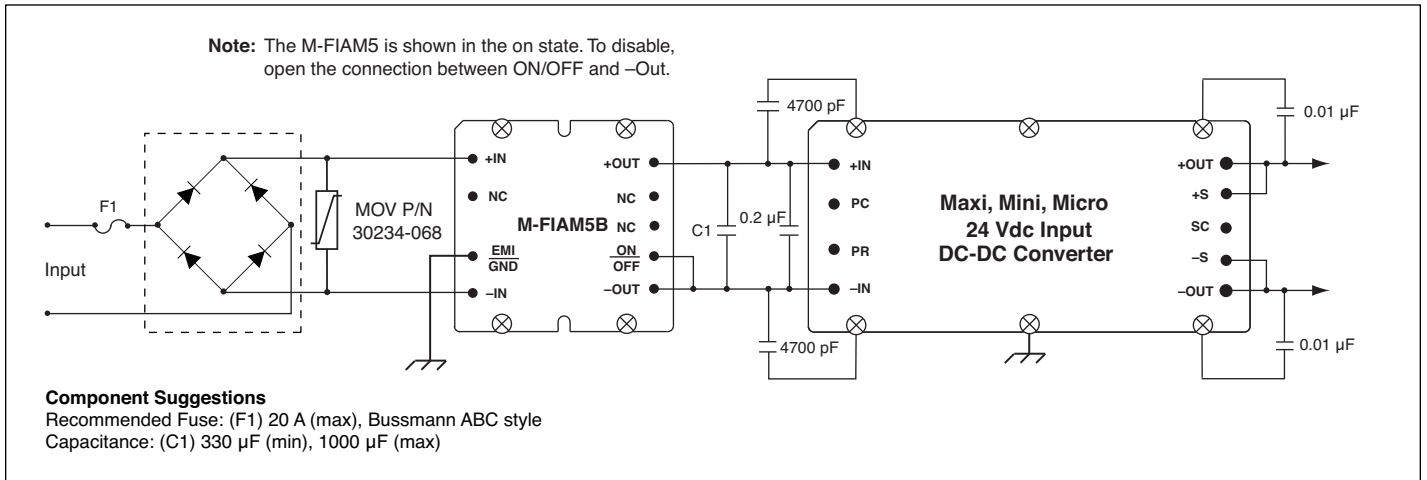

Figure 6—Basic connection diagram with suggested Transient, Surge Protection and Recommended Reverse Polarity Protection.

MECHANICAL DRAWINGS

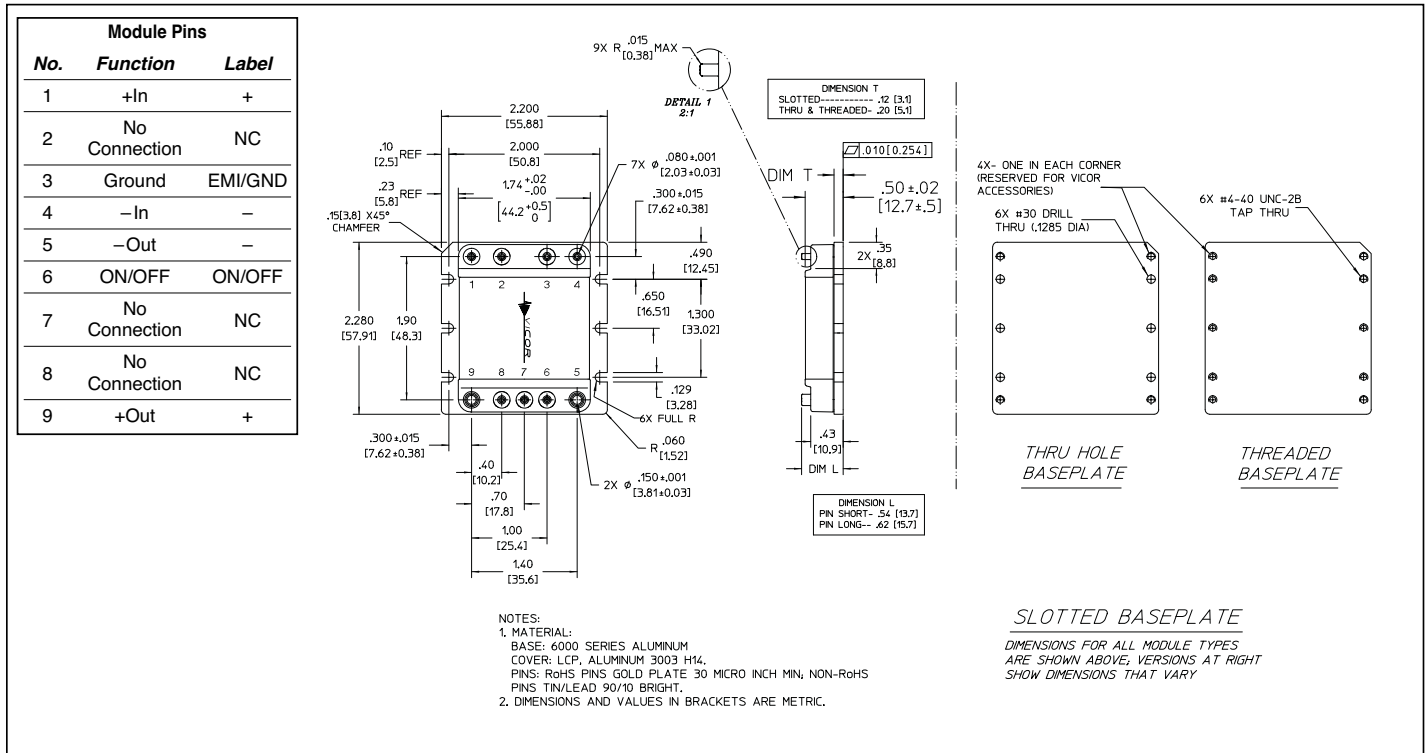

Figure 7 — Mechanical diagram

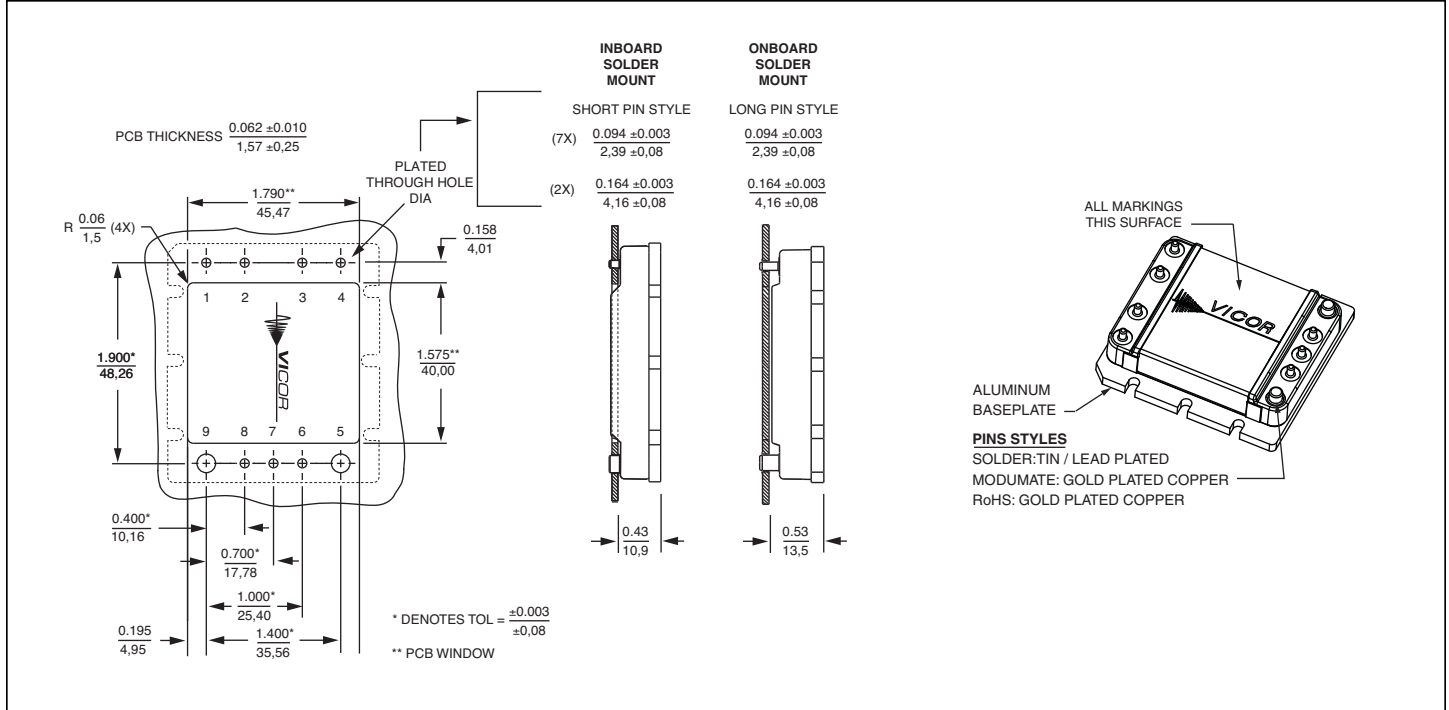

Figure 8 — PCB Mounting Specifications.

Warranty

Vicor products are guaranteed for two years from date of shipment against defects in material or workmanship when in normal use and service. This warranty does not extend to products subjected to misuse, accident, or improper application or maintenance. Vicor shall not be liable for collateral or consequential damage. This warranty is extended to the original purchaser only.

EXCEPT FOR THE FOREGOING EXPRESS WARRANTY, VICOR MAKES NO WARRANTY, EXPRESS OR IMPLIED, INCLUDING, BUT NOT LIMITED TO, THE WARRANTY OF MERCHANTABILITY OR FITNESS FOR A PARTICULAR PURPOSE.

Vicor will repair or replace defective products in accordance with its own best judgement. For service under this warranty, the buyer must contact Vicor to obtain a Return Material Authorization (RMA) number and shipping instructions. Products returned without prior authorization will be returned to the buyer. The buyer will pay all charges incurred in returning the product to the factory. Vicor will pay all reshipment charges if the product was defective within the terms of this warranty.

Information published by Vicor has been carefully checked and is believed to be accurate; however, no responsibility is assumed for inaccuracies. Vicor reserves the right to make changes to any products without further notice to improve reliability, function, or design. Vicor does not assume any liability arising out of the application or use of any product or circuit; neither does it convey any license under its patent rights nor the rights of others. Vicor general policy does not recommend the use of its components in life support applications wherein a failure or malfunction may directly threaten life or injury. Per Vicor Terms and Conditions of Sale, the user of Vicor components in life support applications assumes all risks of such use and indemnifies Vicor against all damages.

Vicor's comprehensive line of power solutions includes high density AC-DC and DC-DC modules and accessory components, fully configurable AC-DC and DC-DC power supplies, and complete custom power systems.

Information furnished by Vicor is believed to be accurate and reliable. However, no responsibility is assumed by Vicor for its use. Vicor components are not designed to be used in applications, such as life support systems, wherein a failure or malfunction could result in injury or death. All sales are subject to Vicor's Terms and Conditions of Sale, which are available upon request.

Specifications are subject to change without notice.

Intellectual Property Notice

Vicor and its subsidiaries own Intellectual Property (including issued U.S. and Foreign Patents and pending patent applications) relating to the products described in this data sheet. Interested parties should contact Vicor's Intellectual Property Department.

Vicor Corporation
25 Frontage Road
Andover, MA, USA 01810
Tel: 800-735-6200
Fax: 978-475-6715

email

Customer Service: custserv@vicorpower.com
Technical Support: apps@vicorpower.com